

**PACKAGE CONTENTS**

ISSUED 09-2009

Revised 2009-09-30

Part	Description	Quantity
A	Crossbar	1pc
B	Green Ground Screw	1pc
C	Lock Washer	2pcs
D	Hex Nut	2pcs
E	Nipple	1pc
F	Ceiling Canopy	1pc
G	Canopy Lock Ring	1pc
H	Ceiling Canopy Loop	1pc
I	Fixture Chain	1pc
J	Fixture Assembly	1pc
K	Side Rod	3pcs
L	Small Ring	3pcs
M	Steel Collar	3pcs
N	Socket Collar	3pcs
O	Shade	3pcs

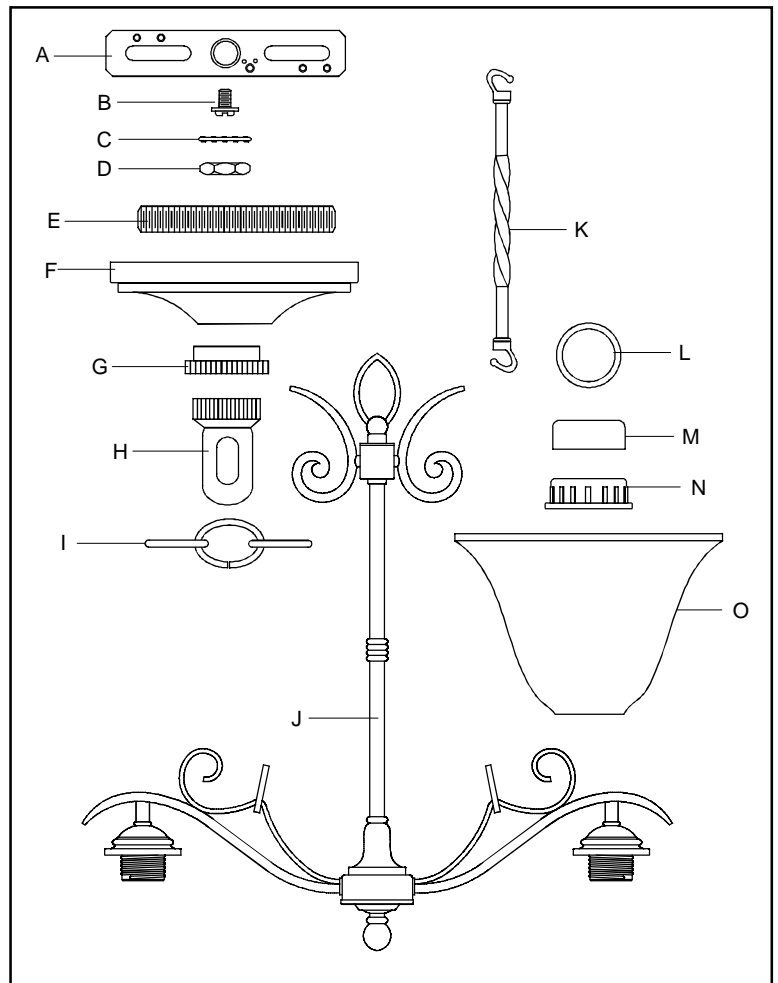

**! WARNINGS AND CAUTIONS**

**WARNING:**

- Before beginning the installation, turn off electricity at the circuit breaker box or the main fuse box by switching off the circuit breaker or removing the fuse.

**CAUTION:**

- These instructions are provided for your safety. It is very important that they are read completely before the installation of your fixture. We strongly recommend that a professional electrician install the fixture.
- Disconnect fixture from the power source before replacing the bulb(s), making sure the bulb(s) had sufficient time to cool down. DO NOT subject the lamp to any shock while lit as shattering of lamp may result.

**PREPARATION**

- Before beginning installation of product, make sure all parts are present. Compare parts with package contents list and diagram above. If any part is missing or damaged, do not attempt to assemble, install or operate the product. Contact customer service for replacement part.
- Estimated Assembly Time : 30 - 45 minutes
- Tools Required for Assembly (not included) : Flathead Screwdriver, Phillips Screwdriver, Pliers, Electrical Tape, Wire Cutters, Safety Glasses & 3, 100 Watt, Type - A Medium Base Bulbs.
- Helpful Tools (not included) : Wire Strippers.

**STEP 1:**

- a. Locate the Rings onto the Scrolls on the side of the Fixture Assembly. Attach the ends of Side Rods onto the Rings on the Scrolls and the Side Arms.

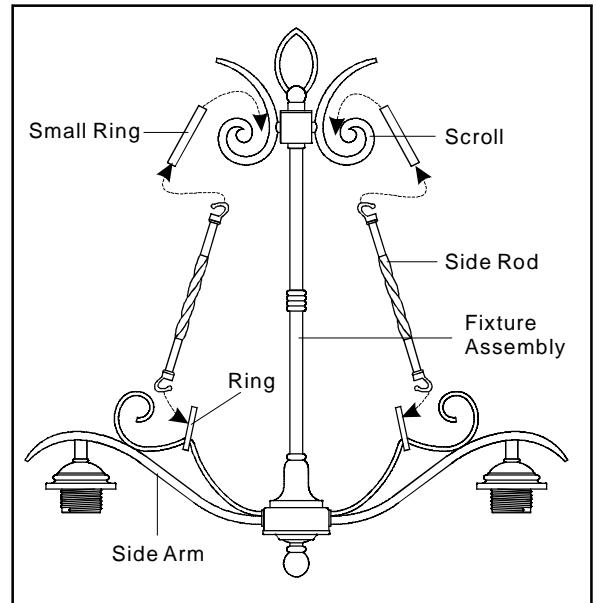

**STEP 2:**

- a. Secure the Crossbar onto the Outlet Box with Outlet Box Screws. Tighten until snug.

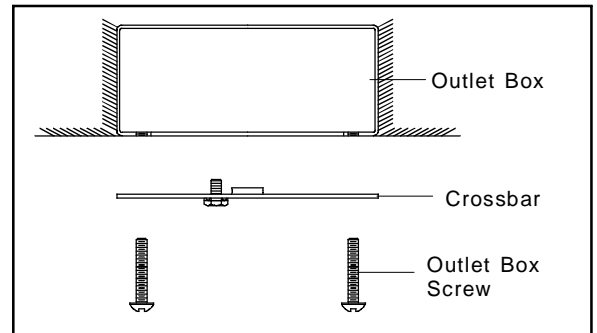

**STEP 3:**

\* Pliers is required on this step.

- a. Thread one Hex Nut onto top end of the Nipple.
- b. Place one Lock Washer over the top end of the Nipple and then thread the Nipple into the center lock hole of the Crossbar.
- c. Using pliers, thread the Hex Nut against the Crossbar and hand tighten until snug.
- d. Thread another Hex Nut onto the bottom end of the Nipple.

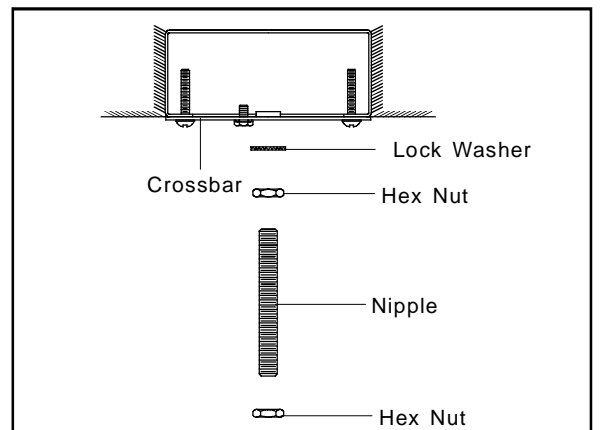

**STEP 4:**

- a. Adjust the Fixture Chain to your desired length by removing the links if needed.  
\* Please note that depends on chain material thickness, you might be required to use chain pliers to spread links open.
- b. Pull the supply wires through the Fixture Chain alternating links. And then pull the wires through the following components in turn: Canopy Lock Ring, Ceiling Canopy, Canopy Chain Loop, Lock Washer, and Nipple.
- c. Place Lock Washer over the end of the Nipple and thread the Canopy Chain Loop onto the end of the Nipple.
- d. Using pliers, thread the Hex Nut against the Canopy Chain Loop and tighten until snug.
- e. Attach one end of the Fixture Chain onto the Fixture Loop and attach the another end of the chain onto the Canopy Chain Loop.
- f. Refer to Step 5 – Wire Connections to connect wires.
- g. Push the Ceiling Canopy upward over the Outlet Box.
- h. Thread the Canopy Lock Ring onto the Canopy Chain Loop and tighten until snug to secure the Ceiling Canopy.

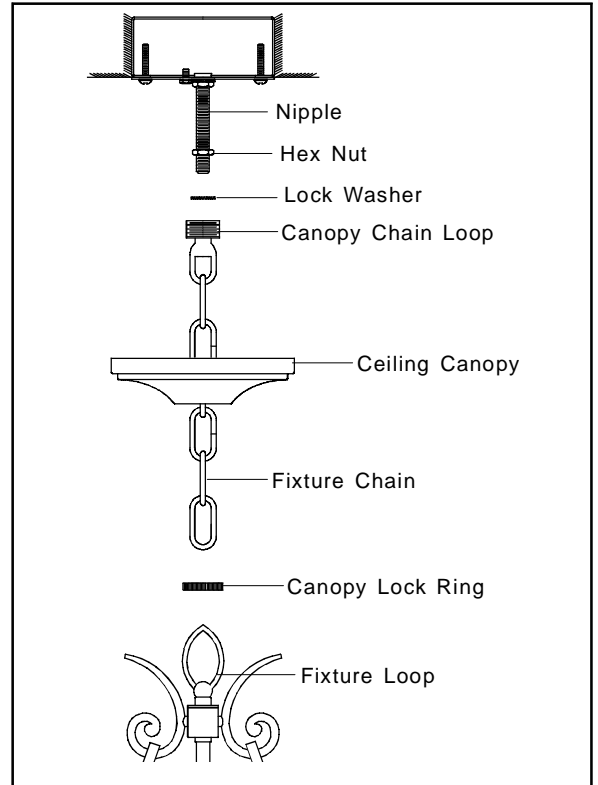

**STEP 5:**

\*Use Wire Connectors (not supplied) to connect the wires.

- a. Connect the House Ground Wire to the Fixture Ground Wire.
- b. Connect the House White (or Ribbed) Wire to the Fixture Supply Wire (White or Ribbed Side).
- c. Connect the House Black (or Red) Wire to the Fixture Supply Wire (Black or Smooth Side).
- d. Wrap each connection with approved electrical tape and carefully stuff all of the connected wires into the Outlet Box.

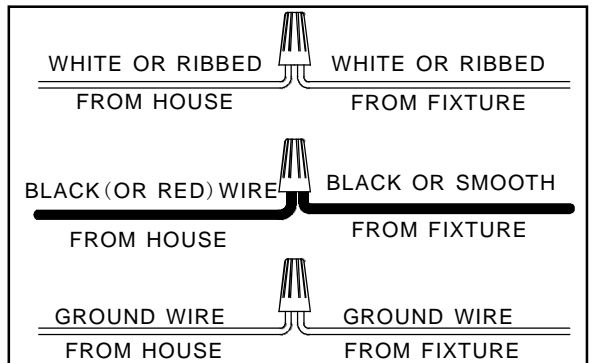

**STEP 6:**

- a. Place the Shade and the Steel Collar over the Socket As shown. Secure by threading the Socket Collar onto the Socket. Hand tighten until snug.

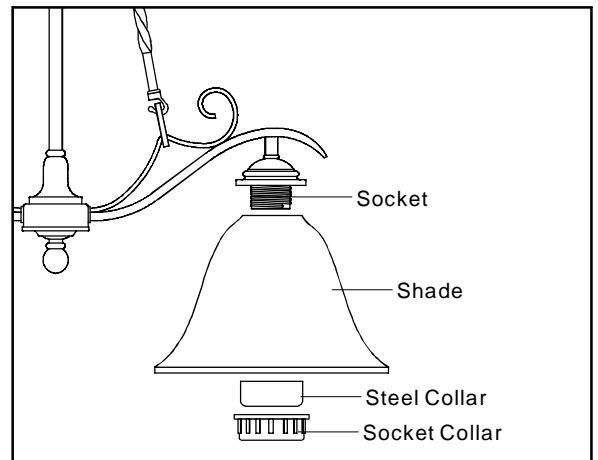

**STEP 7:**

- a. Install correct Bulbs referring to fixture markings and/or labels for maximum wattage.

Your installation is completed now. Restore electricity. Retain this sheet for future reference.