

HOLTKÖTTER INTERNATIONAL, INC.

155 Hardman Avenue South, South St. Paul, MN 55075

fax: (888) 552-8661 • phone: (800) 899-5444

www.holtkoetter.com

e-mail: customerservice@holtkoetter.com

QUICK-CONNECT INSTRUCTIONS

1. Once the LICHTSTAR canopy has been installed, the quick-connect feature completes the fixture.
2. Be sure to discard the nut (A) removed from the canopy and universal backplate assembly, referred to in Step 2 under the Mounting Instructions. This will allow access to the threaded stem (G) at the center of the canopy.
3. Insert the plug (E), located at the end of the cable or reflector, into the center of the threaded stem (G).
4. Slide the finished stem (D) over the plug (E) and screw into place on the threaded stem (G).

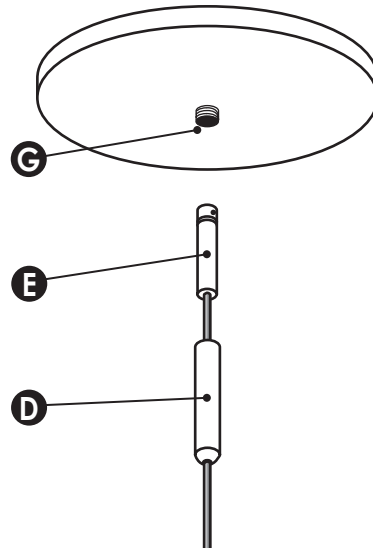
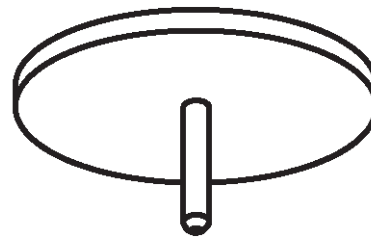
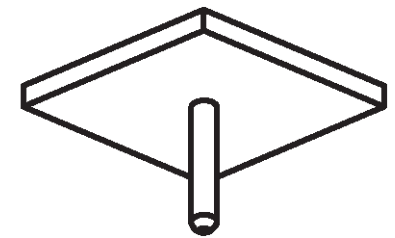

Diagram shows Canopy C-8120 with a cable assembly.

ASSEMBLY INSTRUCTIONS FOR LICHTSTAR Single Canopy No. C-8110, C-8120, C-8140 & C-8150



C-8120



C-8150

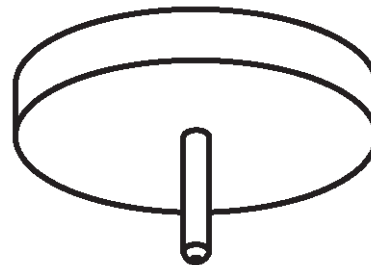

C-8110

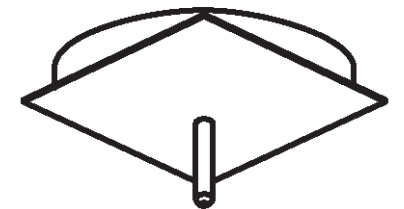

C-8140

CARE INSTRUCTIONS

Use only a soft, dry cloth to clean. If necessary, a slightly damp, soft cloth can be used to spot clean. Do not use common household cleaners on lamps or fixtures, as the lacquer on the outside of the brass may be damaged as a result. Enjoy your new Holtkötter lamp.

HOLTKÖTTER INTERNATIONAL, INC.

www.holtkoetter.com
e-mail: customerservice@holtkoetter.com

MOUNTING INSTRUCTIONS

Please note: if a dimmer is required, it is recommended that a Lutron ELV (Electronic Low Voltage) dimmer be used. It is recommended that this fixture be installed and hung by a licensed electrician.

1. Disconnect the power to the outlet box before servicing.
2. Unscrew the nut (A) holding the finished backplate (B) to the mounting hardware / crossbar strap (C), allowing access to the crossbar strap (C).
3. Connect the wires from the canopy with the wires in the outlet box according to generally accepted electrical standards.
4. Screw the crossbar strap (C) to the outlet box.
5. Secure the finished backplate (B) to the ceiling or canopy by attaching the quick-connect reflector or glass of your choice (diagram and instructions on reverse).
6. The nut (A), removed in Step 2 can be discarded.

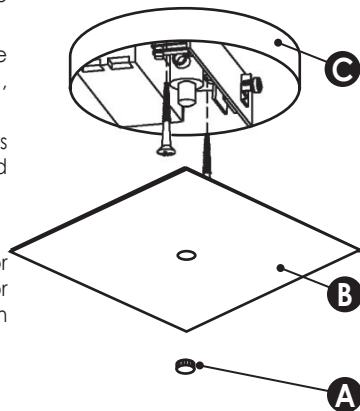

C-8140

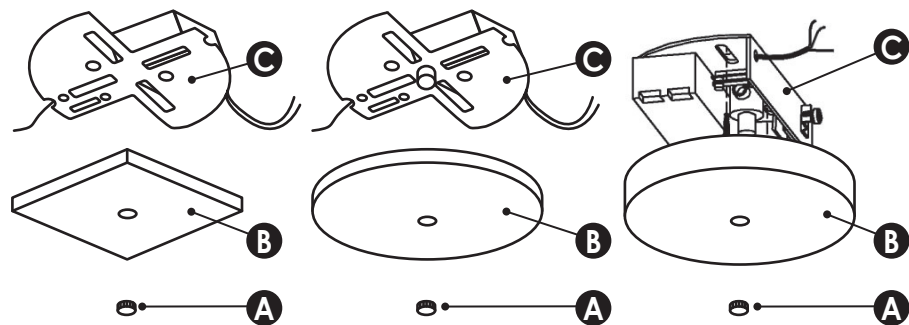

C-8150

C-8120

C-8110

ASSEMBLY INSTRUCTIONS FOR LICHTSTAR Single Canopy No. C-8110, C-8120, C-8140 & C-8150

BULB INSTALLATION

CAUTION: DISCONNECT POWER BEFORE SERVICING.

1. Install the bulb into the socket. Be sure to use the plastic wrap provided with the new bulb to ensure long bulb life. Push the bulb firmly into the socket.
2. The recommended replacement bulbs for this fixture are 50 Watt Halostar IRC bulbs by Osram, Holtkötter Item No. 9250*050-HSTAR. Use of other brands of unknown quality may cause a risk of overheating.

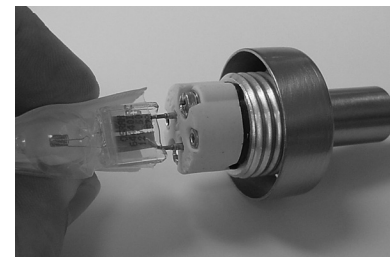

GLASS INSTALLATION

3. Slide the glass over the socket. Using the plastic nut driver provided, insert the nut driver on the inside of the glass and tighten the nut until the glass is snug against the fixture.
4. Make sure the glass is secure, but not over-tightened.

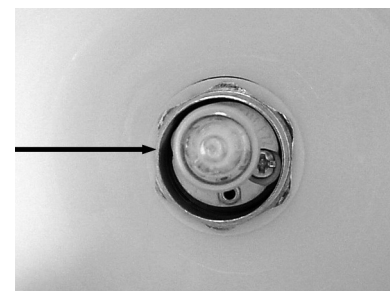
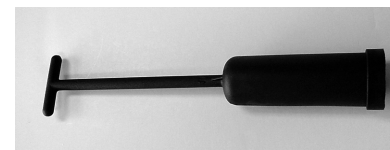

HOLTKÖTTER INTERNATIONAL, INC.

155 Hardman Avenue South, South St. Paul, MN 55075

fax: (888) 552-8661 • phone: (800) 899-5444

www.holtkoetter.com

e-mail: customerservice@holtkoetter.com

BULB INSTALLATION

CAUTION: DISCONNECT POWER BEFORE SERVICING.

1. Install the bulb into the socket. Be sure to use the plastic wrap provided with the new bulb to ensure long bulb life. Push the bulb firmly into the socket.
2. The recommended replacement bulbs for this fixture are 50 Watt Halostar IRC bulbs by Osram, Holtkötter Item No. 9250*050-HSTAR. Use of other brands of unknown quality may cause a risk of overheating.

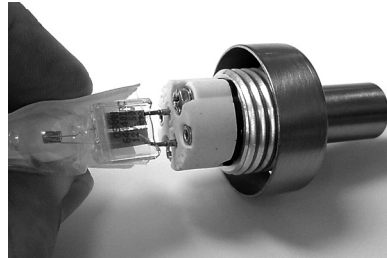

GLASS INSTALLATION

3. Slide the glass over the socket. Using the plastic nut driver provided, insert the nut driver on the inside of the glass and tighten the nut until the glass is snug against the fixture.
4. Make sure the glass is secure, but not over-tightened.

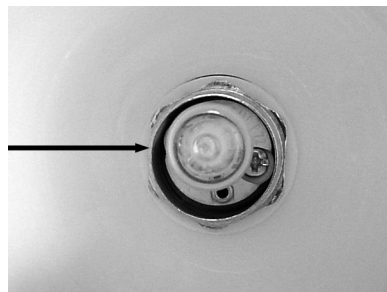
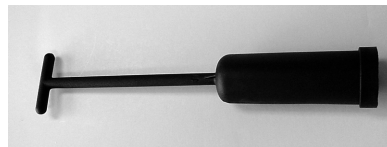

For Holtkötter Reflectors R-5900, R-5910, R-5920, R-9731, R-9732 and R-9740 or Holtkötter Glass G-5631 and G-5770, please refer to the instructions provided with the reflector or glass kit.

ASSEMBLY INSTRUCTIONS FOR Lichtstar System Suspension Kit No. S-006 & S-012



CARE INSTRUCTIONS

Use only a soft, dry cloth to clean. If necessary, a slightly damp, soft cloth can be used to spot clean. Do not use common household cleaners on lamps or fixtures, as the lacquer on the outside of the brass may be damaged as a result. Enjoy your new Holtkötter lamp.

HOLTKÖTTER INTERNATIONAL, INC.

www.holtkoetter.com
e-mail: customerservice@holtkoetter.com

Please install the ceiling canopy using the mounting instructions provided with the canopy prior to making the quick connection with this kit.

If the length of cable is too long for the required application, follow the instructions on how to shorten the cable prior to installing the bulb and glass.

QUICK-CONNECT INSTRUCTIONS

DIAGRAM 1

1. Once the LICHTSTAR canopy has been installed, the quick-connect feature completes the fixture.
2. Insert the plug (B), located at the end of the cable, into the center of the threaded stem (C).
3. Slide the finished stem (A) over the plug (B) and screw into place on the threaded stem (C).

DIAGRAM 1

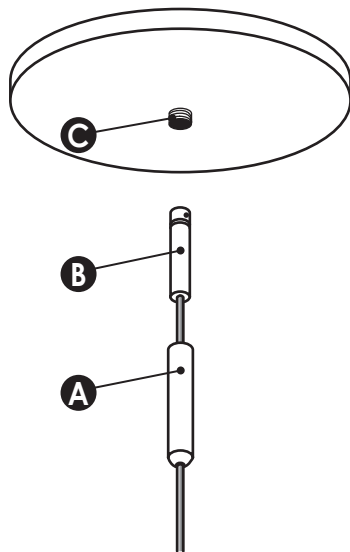

Diagram shows Canopy C-8120 with a cable assembly.

ASSEMBLY INSTRUCTIONS FOR Lichtstar System Suspension Kit No. S-006 & S-012

SMALL PARTS BAG

PHOTO 1

In the event the cable needs to be shortened, a small parts bag has been included. Items in the small parts bag include:

1. 1X 2.0 mm allen wrench (I)
2. 1X Large metal sleeve (H)
3. 2X Small metal sleeves (J)
(only need both if cable is not shortened correctly the first time)
4. 1X 2 mm set-screw (F)
(only need if an original set screw gets lost or stripped)

PHOTO 1

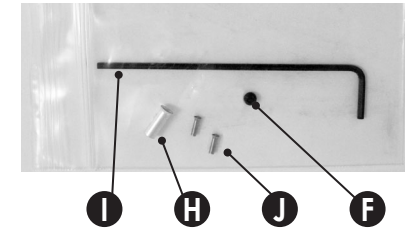

SHORTEN THE CABLE

PHOTO 2

1. To shorten the cable (K), locate the quick-connect pin (E) at the end of cable that plugs into the canopy.
2. With the 2.0 mm allen wrench (I) provided, loosen the two set screws (F) located on the pin and remove the cable from the pin. On the large end of the pin, use a needle-nose pliers to remove the large metal sleeve.
3. Cut cable (K) to the desired length.
4. Strip the inside wire (G) to the length of the small metal sleeve (J) sent in the plastic parts bag (two have been sent as a precaution, only one is needed for installation). Slide the small metal sleeve over the inside wire and crimp in place.
5. Slide the outside cable sheathing about 3/4 inch away from the small crimp, so that the sheathing lines up with the of wider part on the pin (E). Place the large metal sleeve (H) over the sheathing in this position. Do not crimp this sleeve, as the set screw will hold it in place.
6. Insert the shortened cable into the pin (E), aligning the metal sleeves with the corresponding set screw and tighten each into place. **DO NOT OVER TIGHTEN.** Please note: if the set screws are not tightened sufficiently or do not line up to connect with the metal sleeves on cable, the fixture will not light. Additionally, over tightening of the set screws could cause the fixture to short out and not light.

PHOTO 2

