









# ASSEMBLY INSTRUCTIONS

## 45016 SOFA TABLE

### COMPONENT AND PARTS LIST

1	TOP & APRON	1 PC
2	METAL LEG	4 PCS
3	BOTTOM SHELF / DRAWER BOX	1 PC
4	METAL SCROLL	2 PCS
5	DRAWER	2 PCS
6	TRAY	2 PCS

#	HARDWARE		QTY	EXT
A	M5/16" X 1-3/8" ALLEN-HEAD BOLT		8 PCS	1 PC
B	M5/16" SPRING WASHER		8 PCS	1 PC
C	M5/16" FLAT WASHER		8 PCS	1 PC
D	M5/16" ALLEN WRENCH		1 PC	
E	M1/4" X 3/4" ALLEN-HEAD BOLT		4 PCS	1 PC
F	M1/4" SPRING WASHER		4 PCS	1 PC
G	M1/4" FLAT WASHER		4 PCS	1 PC
H	M1/4" ALLEN WRENCH		1 PC	

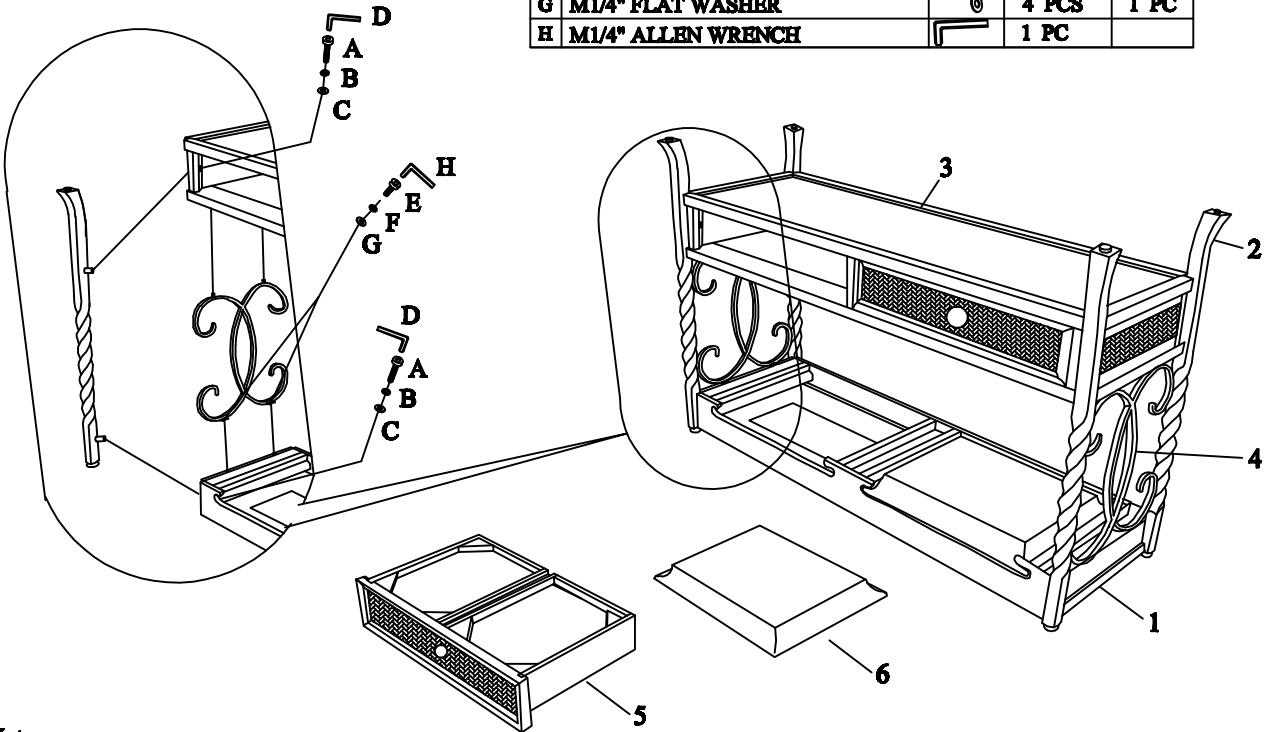

#### Note:

- Do not discard any packing materials until the table has been completely assembled, to prevent parts from being accidentally discarded.
- To prevent possible scratches or damage, assemble the table upside down on a soft surface such as a blanket or carpet.
- Remove the two trays from the Top & Apron and lay them aside. Remove the drawers from the Bottom Shelf / Drawer Box and lay them aside. Note which compartment each drawer and tray is removed from so they can be reinstalled back into the same compartment later.
- Attach Metal Legs to the Top & Apron using four 1-3/8" Allen-head bolts (A), Spring Washers (B), and Flat Washers (C), into the inside corner of the legs. Only partially install bolts until after step #7.
- Attach Metal Scroll to bottom side of Top & Apron using two 1/4" x 3/4" Allen-Head Bolts (E), Spring Washers (F) and Flat Washers (G). Do not fully tighten until after step #7.
- Place the Bottom Shelf / Drawer Box onto the locator pins on the bottom of the Metal Scroll, while also pulling the Metal legs into position with the Bottom Shelf.
- Attach the Bottom Shelf / Drawer Box to the Metal Legs using the four 1-3/8" long Allen-Head bolts (A), Spring Washers (B) and Flat Washers (C).
- Tighten all bolts using the supplied Allen Wrenches, (D or H).
- Carefully turn the Table upright and reinstall the trays and drawers.