



ISO 9001-2008 CERTIFIED

NOCTURNAL CARE CLINER[®]

OWNER'S OPERATING &
MAINTENANCE MANUAL



*For Models:
6980-6988 & 6990-6998*



PLEASE DO NOT DISCARD THIS MANUAL! KEEP FOR FUTURE REFERENCE AND TRAINING

TABLE OF CONTENTS/WARRANTY

| | |
|-------------------------------------|------------|
| IMPORTANT SAFETY INFORMATION..... | 2-3 |
| ASSEMBLY INSTRUCTIONS..... | 4 |
| OPERATING INSTRUCTIONS..... | 5-7 |
| GENERAL MAINTENANCE..... | 8 |
| SPECIFICATIONS..... | 9 |
| NOCTURNAL CARE CLINER OPTIONS..... | 10 |
| CONTACT & WARRANTY INFORMATION..... | BACK COVER |

UNPACKING

1. CAREFULLY EXAMINE YOUR PRODUCT FOR ANY DAMAGE. INSPECT ALL COMPONENTS. IF DAMAGE IS EVIDENT, CONTACT FREIGHT CARRIER OR WINCO IMMEDIATELY.
2. REMOVE ALL PACKING MATERIAL AND HARDWARE THAT WAS SECURED FOR SHIPPING.
3. CAREFULLY REMOVE ALL OF THE COMPONENTS FROM THE CARTON.
4. SAVE ALL BOXES AND PACKING MATERIAL UNTIL AFTER YOU HAVE ASSEMBLED YOUR PRODUCT AND HAVE VERIFIED THAT ALL COMPONENTS ARE FUNCTIONING PROPERLY. (IF DAMAGE IS EVIDENT, CONTACT THE FREIGHT CARRIER OR WINCO IMMEDIATELY!)

Winco assumes no responsibility for damage or injury caused by the improper assembly, installation, use or maintenance of these products.

! IMPORTANT!

PLEASE READ THIS ENTIRE MANUAL BEFORE USING CHAIR. DO NOT INSTALL, MAINTAIN OR OPERATE THIS EQUIPMENT WITHOUT READING AND FOLLOWING THIS MANUAL. OTHERWISE INJURY AND/ OR DAMAGE MAY RESULT.

THE INFORMATION CONTAINED IN THIS MANUAL IS SUBJECT TO CHANGE WITHOUT NOTICE. **SAVE THESE INSTRUCTIONS FOR FUTURE REFERENCE!**

NO PART OF THIS MANUAL MAY BE DUPLICATED IN ANY FORM WITHOUT THE PRIOR CONSENT OF WINCO, INC. UNAUTHORIZED DUPLICATION MAY RESULT IN CIVIL PROSECUTION TO THE MAXIMUM EXTENT ALLOWED BY LAW.

Products with the following markings are intended for commercial use only.



100-240
VAC
44W,
50-60Hz

WARNING: Long-term, continuous exposure to heat may cause burns. Read instructions before using. DO NOT use wet. DO NOT insert pins into upholstery.



IMPORTANT - PLEASE READ



FOR PRODUCTS WITH POWERED OPTIONS (Heat, Massage, etc...)

Read all instructions before using this product.

IMPORTANT SAFETY INSTRUCTIONS - SAVE THESE INSTRUCTIONS

To reduce the risk of electric shock when using an electrical appliance, basic precautions should always be followed, including the following:

DANGER - Always unplug this product from the electrical outlet before cleaning, maintenance or when putting on or taking off parts.

WARNING:

1. Unplug this product from the electrical outlet if this product is not to be used for extended periods of time.
2. Supervision should be provided when this product is used by, on, or near children, invalids, or disabled persons.
3. Use this product only for its intended use as described in this manual. Do not use attachments not recommended by the manufacturer.
4. Never operate this product if it has a damaged cord or plug, if it is not working properly, if it has been dropped or damaged, or dropped into water. Return the product to an authorized Winco service center.
5. DO NOT carry or pull this product by power supply cord or use the cord as a handle.
6. Keep the cord away from heated surfaces.
7. Do not use outdoors.
8. To disconnect, turn all controls to the "off" position, then remove plug from outlet. Do not "yank" cord.
9. Clean switch with a damp cloth only – Warranty will be VOID if liquid is introduced into switch mechanism.
10. Use only a certified extension cord that is rated at 15 amperes; extension cords rated for less amperage may over heat. Care should be taken to arrange the cord so that the cord cannot be pulled or tripped over.
11. DO NOT run recliner or other equipment over cord.
12. Recliner comes with a grounded three blade plug, if the plug does not fit into the outlet; contact a certified electrician to install the proper outlet. DO NOT MODIFY THE PLUG IN ANY WAY.

DANGER:

- i) Never insert pins, or attach other metallic fasteners into/onto the upholstery of this chair.
- ii) Do not use this product if the covering shows signs of deterioration, such as checking, blistering, or cracking.
- iii) KEEP DRY - Do not operate in a wet condition or environment.

WARNING:

- i) Long term, continuous exposure to heat may cause burns. It is recommended that skin in contact with heated area be checked for redness and blistering during long term usage. Do not use on an infant, invalid or unconscious person. Do not use on insensitve skin or on a person with poor blood circulation. If you are uncertain if you should use this product, please consult your physician about the use of heat and massage.
- ii) Do Not Crush/Pinch heating elements or wiring.

WARNING: Connect this product to a properly grounded outlet only. (see grounding instructions, pg 3)



IMPORTANT - PLEASE READ

GROUNDING INSTRUCTIONS:

This product must be grounded. If it should malfunction or breakdown, grounding provides a path of least resistance for electric current to reduce the risk of electric shock. This product is equipped with a cord having an equipment-grounding conductor and a grounding plug. The plug must be plugged into an appropriate outlet that is properly installed and grounded in accordance with all local codes and ordinances.

DANGER - Improper connection of the equipment-grounding conductor can result in a risk of electric shock. Check with a qualified electrician or serviceman if you are in doubt as to whether the product is properly grounded. Do not modify the plug provided with the product - if it will not fit the outlet, have a proper outlet installed by a qualified electrician.

This product is for use on a nominal 120-volt circuit and has a grounding plug. Make sure that the product is connected to an outlet having the same configuration as the plug. No adapter should be used with this product.

For an added level of safety; Winco recommends the use of a 120 volt GFCI (ground fault circuit interruptor) outlet.

WARNING

DO NOT LIFT OR CHANGE CHAIR POSITION BY USING THE LEGREST.

*This could injure the user or damage the recline mechanism and will void warranty.
Always change position using Release Handles on side or rear of chair.*

1. READ AND FOLLOW ALL DIRECTIONS.
2. Keep children away from extended foot support (or other similar parts).
3. DO NOT put hands, feet or clothing into any openings when changing positions on recliner. Attendant MUST confirm that users arms, legs, hands and feet are safe while changing recliner positions or SERIOUS INJURY MAY RESULT.
4. Lock casters at all times, except when transporting chair.
5. STAY CLEAR of the recliner mechanisms.
6. DO NOT use recliner for transporting in or with ANY type of vehicle or trailer. Winco recliners have not been tested or approved for use by an occupant in any type of vehicle or trailer.
7. NEVER use the chair arms or backrest as a seat; SERIOUS INJURY or damage may occur.
8. Periodically check the tightness of all nuts, bolts and screws.
9. Immediately REMOVE FROM SERVICE; Any recliner with broken recline mechanisms, torn upholstery, or other mechanical or visible damage.
10. NEVER transport user with chair arms in an "open or down" position. *Applies to Drop-Arm & Swing-Arm models.*
11. USE ONLY WINCO AUTHORIZED REPLACEMENT PARTS.
12. NEVER EXCEED the recommended weight capacity - see page 10.



ASSEMBLY INSTRUCTIONS

BACK ASSEMBLY INSTRUCTIONS

1. Carefully remove back assembly and chair frame from carton.
Note: Handle with care when removing chair from box. This will ensure that no damage is done to the cables and/or wiring that connects the back to the chair.
2. Lock ALL (3) total-lock casters on chair base. (see Lock/Unlock Casters page 6).
NOTE: Make sure the footrest is in closed position before installing the back.
3. Cut the "zip-tie notice tag" on the back mechanism fork, located behind the seat.
4. Pull UP on the back adjustment handle (FIG.2A) to bring the back mechanism (FIG.2B) into its upright position.
5. Using 2 people (RECOMMENDED), have one person grab the Push Handle on the back, and hold the back in position over mounting forks. Align the forks on base (FIG. 3A) with the guides on back (FIG. 3B).
6. Slide the guides onto the mounting forks until the guides "SNAP" or click into their proper location. (Circled, FIG.3A).
7. Once the back has been tested for proper installation, close the "hook & loop" flaps.

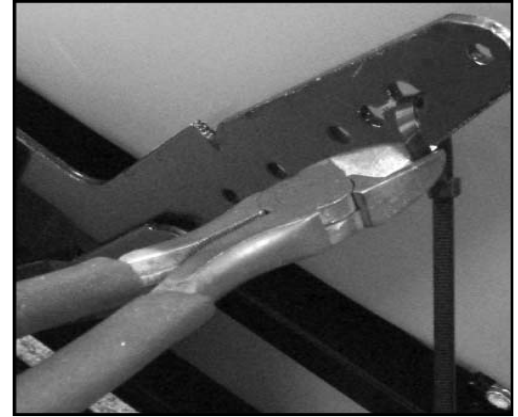

FIG. 1

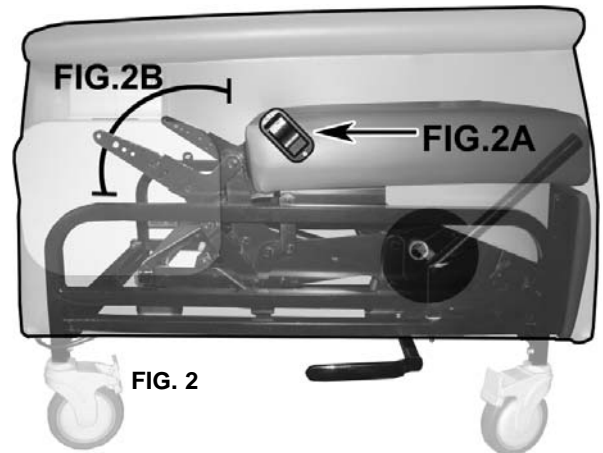

FIG. 2

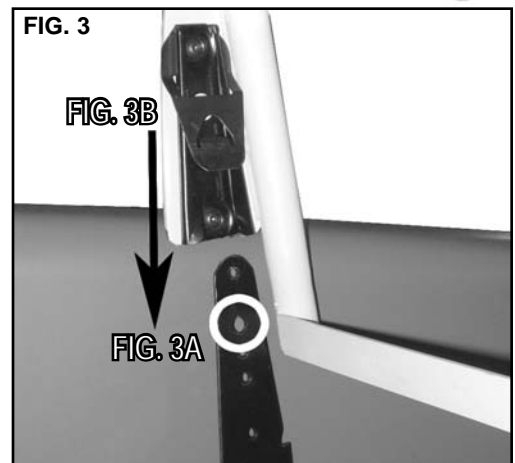

FIG. 3



IMPORTANT



Test to ensure the back has been properly installed by pulling up on the back's push handle.

The back should remain securely in place



IMPORTANT



REGULARLY lubricate pivot points on the Recline Mechanism with a silicone based lubricant. Once per week, position the Chair Back into full recline position, squeeze release handle and go to full Trendelenburg position. This will keep the gas cylinder lubricated. Periodically recheck tightness of all screws, bolts and nuts.

OPERATING INSTRUCTIONS

RECLINING THE CARE CLINER & TRENDELENBURG

(Figures 3 & 4-1 are attendant operated ONLY)

1. **LEGREST ELEVATION:** From the "SEATED UPRIGHT" position, grip the Legrest Handle and pull towards the back of the chair until handle stops **(FIG.1)**.
2. The back can be adjusted to infinite recline positions. To do so, lift the Back Release Handle, then position the chair Back to the desired position and release the handle **(FIG.2)**. Attendants can also adjust the recline position by pulling up on the Back Release Handle located in on back of chair under the push handle **(FIG. 3)**.
3. **TRENDELENBURG** (or lowering the back farther than the positions specified in the above steps) **CAN ONLY BE PERFORMED BY AN ATTENDANT.** **(FIG. 4, #1 & #2)**

To LOWER the Back into the Trendelenburg position: Recline the chair to full recline; Depress the Foot Lever **(FIG. 4, #1)** and continue to push Back down to the Trendelenburg position. **(FIG. 4, #2)**

Lift foot off of lever once Trendelenburg position is achieved.

4. To RAISE the chair Back upwards from Trendelenburg: Pull up on the back. **(FIG. 4, #2)** For further upward adjustment, pull out on either Back Release Handle **(FIG. 2 or 3)** until the desired position is reached, or until chair back is fully upright.

DO NOT FORCE back of chair downward without engaging either of the two Release Handles. This can damage the chair. The chair back will stay in any position when you remove your hand from the handles.

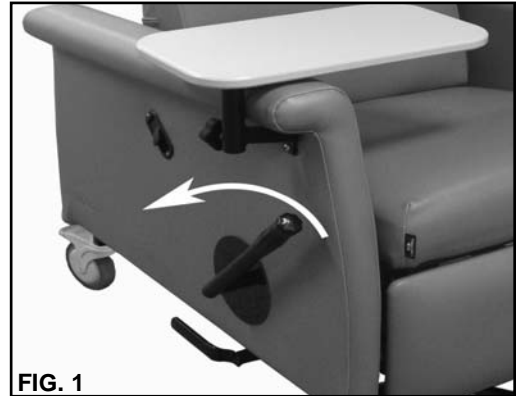

FIG. 1

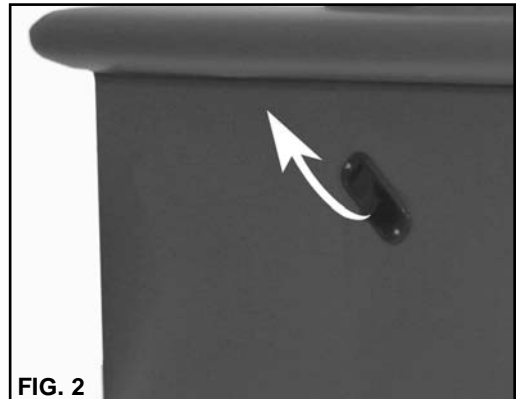

FIG. 2

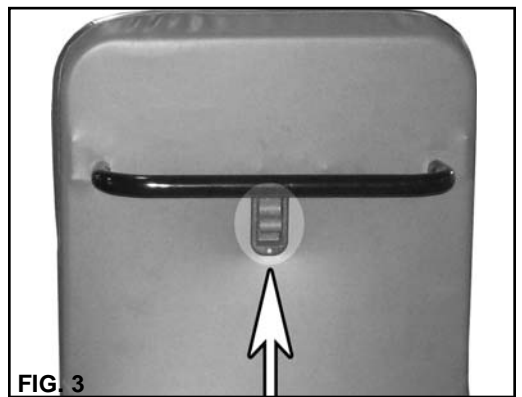

FIG. 3

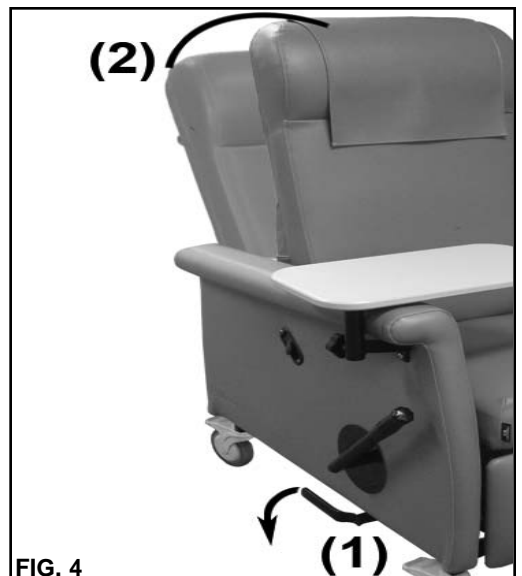

FIG. 4

⚠ NOTE: If the chair back does not recline when the Back Release Handle is pulled, or does not remain in the correct reclined position when the Release Handle is released, cable tension must be adjusted. **Refer to Adjusting Gas Spring on page 8.**

DO NOT push or pull footrest to position chair.

DO NOT stand or sit on the footrest.

DO NOT place hands, legs or feet under seat, legrest or footrest. Stay clear of recline mechanism.

KEEP CHILDREN AWAY from the underside of chair. Injury may occur.

OPERATING INSTRUCTIONS (cont'd)

LOCK/ UNLOCK CASTERS (*Total-Lock vs. Directional*)

1. **Total-Lock casters** will lock wheel and swivel mechanism by using your foot & pushing down on the tab. Both front and the right-rear casters are Total-Locks. These are identified with lighter gray tabs.

Directional caster is used to help steer the chair (*Left rear only*). The tab locks the swivel mechanism; The wheel does not lock on this caster. It is identified with a darker gray tab. (FIG. 1)

2. Release the locking mechanisms by pushing the above described tabs back to horizontal position. (FIG. 2 to FIG. 1)

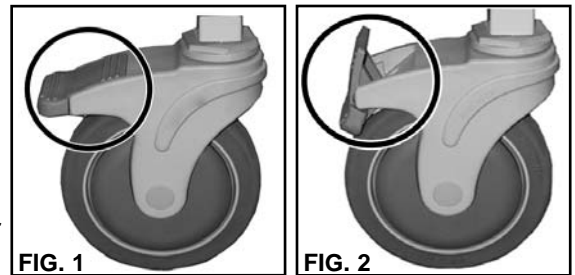

TO POSITION SIDE TABLE

1. To raise table, grasp center of table and gently raise into place. Table will automatically lock into place when released. (FIG. 3)
2. To lower table, grasp table at the center, raise and pivot down in one movement.



TO POSITION PIVOT TABLE

1. To adjust the pivot table position, loosen the adjustment knob and swing away or place in the "lap" position. Tighten knob to secure position. (FIG. 4)
2. To remove pivot table from chair, loosen the adjustment knob and pull up on pivot table.



SWING-ARM OPERATION

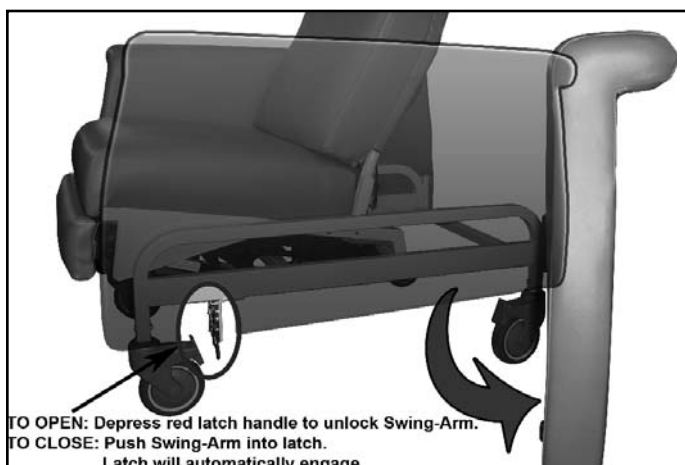

WARNING

- DO NOT** lean or sit on side tables. Tables may break and cause injury.
- DO NOT** allow patients to raise from chair using side tables.
- DO NOT** allow weight to be placed on open swing-arms. Arms may become damaged and fail to close or latch properly.



OPERATING INSTRUCTIONS (cont'd)

HEAT & MASSAGE OPTIONS

Control is located on the inside of right arm of chair.



Heating: Push HEAT button - See indicator light on switch

3 Lights = High Heat / Bright Light

2 Lights = Medium Heat / Med Light

1 Light = Low Heat / Dim Light

No Light = HEAT OFF

Allow 5-8 minutes for back and seat to warm to desired TEMP. setting.

Heat will automatically shut off after approximately 60 minutes. *(Timer resets when switch is pressed)*

Massage (optional): Push MASSAGE button

1X = Lower Back / Low Intensity

2X = Lower Back / High Intensity

3X = Upper & Lower Back / Low Intensity

4X = Upper & Lower Back / High Intensity

5X = MASSAGE OFF

Massage will automatically shut off after approximately 15 minutes. *(Timer resets when switch is pressed)*

- Use a DAMP CLOTH ONLY to clean switch, wiring or power pack (located under seat frame).
- If there is no heat or massage or flashing light on switch - check power cord connections to wall outlet AND connection of power cord to power pack unit under chair.
- If switch displays a flashing light; Check all accessible wire connectors under chair for possible loose connections, then contact Winco customer service: 1-800-237-3377.



FIG. 1

CORD STORAGE

(Models with Heat-HT or Heat & Massage-HM)

1. Before transporting chair, or when heat & massage is not in use, power cord should be coiled and stored in the "Hook & Loop" fastener provided as shown, to prevent tripping on cord, damage to cord, damage to recliner, etc... **(FIG. 1)**



GENERAL MAINTENANCE

ADJUSTING GAS SPRING

NOTE: Tension or "ease of movement" of the gas spring is set by factory and cannot be changed.

1. Using 2 people (RECOMMENDED), tilt the chair over onto the Left side and locate the Gas Spring (**FIG. 1**). Loosen the 11/16" hex nut on the Gas Spring located near the bottom-front of the chair. (**FIG.2**)
2. On the opposite end of Gas Spring, remove the Bow-Tie Cotter Pin and Clevis Pin - (save the 2 plastic Clevis Pin bushings) (**FIG.3**) Gas Spring can now be rotated for adjustment.
3. If Back of chair will not recline when "back release handles" are lifted then you will need to Rotate the Gas Spring as shown, clockwise, one half (1/2) of a revolution (or 180 degrees) - see (**FIG. 4A**). If Back of chair reclines without lifting handles; then you will need to Rotate Gas Spring as shown, counter-clockwise, one-half (1/2) of a revolution (or 180 degrees). (**FIG. 4B**)
4. Once you make an adjustment; Replace Clevis Pin, plastic bushings and Bow-Tie Cotter Pin. Pull up on the Back Adjustment Handle to check for proper adjustment. Repeat above steps as needed until correct release action is achieved. Then TIGHTEN HEX NUT (that you loosened in step 1) once the Gas Spring is adjusted properly.

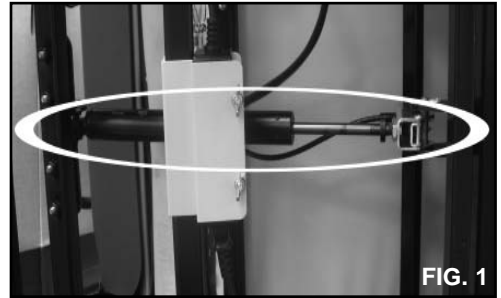

FIG. 1

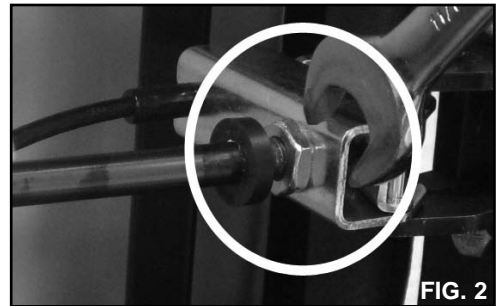

FIG. 2



FIG. 3

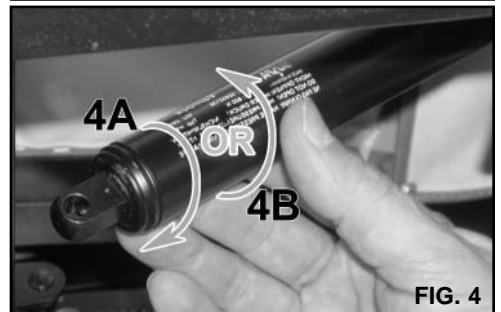

FIG. 4

WARNING

-Make sure all bow tie cotter pins are securely inserted in all clevis pins and that cable end is attached through slot of Operator.

-Failure to securely insert the bow tie cotter pins into the clevis pin could cause the clevis pins to fall out and result in injury, or damage to the chair.

GENERAL CARE & CLEANING

Remove hair & body oils; Your recliner should be cleaned with mild soap & water solution and a damp cloth on a regular basis (especially where skin & hair make contact with upholstery). Avoid harsh detergents or chemicals that could damage the upholstery or finish of your recliner. If the recliner is disinfected, the chair MUST be wiped off with ONLY clean water on a damp cloth.

Note: Disinfectants alone, will not provide adequate "grease or oil cutting" properties to remove hair & skin oils. Over time, the appearance and feel of your upholstery may diminish if not cleaned properly.

Please refer to the **PERMABLOK** instruction tag that is attached to your Care Cliner for complete care and cleaning instructions. *Retain information on tag for future use.*

FOR FURTHER CLEANING INFORMATION VISIT:

<http://www.wincomfg.com/permablok-info-and-cleaning-instructions>



6980 & 6990 SPECIFICATIONS



6980 - Specifications

| | | | |
|--|-------|-----------------------------|----------|
| Seat Height | 23.5" | Back Height Above Seat..... | 32.5" |
| to Footrest Plate..... | 16.5" | Seat Depth..... | 21.5" |
| Seat Width..... | 21" | Weight | 167 lbs. |
| Overall Height | 52.5" | | |
| Overall Width (<i>Trays Down</i>)... | 34.5" | | |
| (<i>Trays Up</i>)..... | 44" | | |

Maximum Weight Capacity....350 lbs.

6990 - Specifications

| | | | |
|--|-------|-----------------------------|----------|
| Seat Height | 23.5" | Back Height Above Seat..... | 32.5" |
| to Footrest Plate..... | 16.5" | Seat Depth..... | 21.5" |
| Seat Width (arm to arm)..... | 28" | Weight | 174 lbs. |
| Overall Height | 52.5" | | |
| Overall Width (<i>Trays Down</i>)... | 39.5" | | |
| (<i>Trays Up</i>)..... | 49" | | |

Maximum Weight Capacity....500 lbs.



NOCTURNAL CARE CLINER OPTIONS

Heat & Massage

HMHeat & Massage
 HTHeat ONLY

FACTORY INSTALLED ONLY



IV Pole & Attachment

IV..... IV Pole & Attachment



Oxygen Tank Holder

O2.....Oxygen Tank Holder



Versa-table

VN.....Single Versa
 FACTORY INSTALLED ONLY



(Left-side ONLY)

Armrest Covers

AC00.....Armrest Covers (Pair)

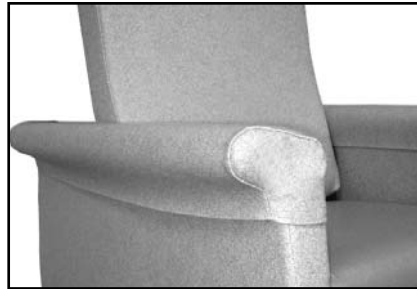

Side Cushion

SC00.....Side Cushion

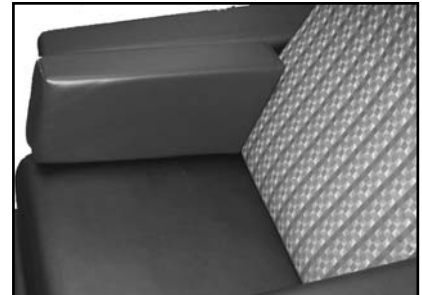

LIMITED WARRANTY

TERMS

Winco Mfg., LLC. warrants this product to be free of manufacturer's defects in material and workmanship, provided that the product is used according to normal operating conditions and proper maintenance intended by manufacturer. This warranty is available only to the original retail purchaser, is non-transferable and commences on the date of retail sale; proof of purchase required.

LIMITED ONE YEAR COMPLETE PRODUCT WARRANTY: Winco Mfg., LLC. warrants the complete product for one (1) year. At Winco Mfg., LLC. sole discretion, it may repair or replace any components freight free that are found to be defective during the first year. Winco Mfg., LLC. shall not be liable for any labor, or any other costs incurred as a result of or in conjunction with a warranty claim.

LIMITED THREE YEAR WARRANTY: Winco Mfg., LLC. warrants the recliner mechanisms, electrical components, vinyl [from cracking or delaminating] pressurized gas springs, when new, for a period of three (3) years. At Winco Mfg., LLC. sole discretion, it may repair or replace components found to be defective. Winco Mfg., LLC. shall not be liable for any labor, shipping or any other costs incurred as a result of or in conjunction with a warranty claim.

LIMITED LIFETIME CHAIR FRAME WARRANTY: Winco Mfg., LLC. warrants the steel chair frame, when new, for the lifetime of the original purchaser. This limited warranty does not apply to paint/finish or any components attached to the frame such as; upholstery, foam, casters, mechanisms or related parts that are covered under above warranties. Winco Mfg., LLC. shall not be liable for any labor, shipping or any other costs incurred as a result of or in conjunction with a warranty claim.

The purchaser's exclusive remedy under this warranty shall be limited to such repair or replacement of defective components at Winco Mfg., LLC. sole discretion. For warranty service, contact the dealer that the product was originally purchased from or Winco Mfg., LLC. directly.

EXCLUSIONS

There are no other warranties, conditions, representations or guarantees, express or implied, made or intended by Winco Mfg., LLC., and all other warranties, conditions, representations or guarantees including any warranties, conditions, representations or guarantees under any Sale of Good Act or Like legislation or statute is hereby expressly excluded. Any and all other implied warranties shall not extend beyond the duration of the express warranty. Liability for incidental or consequential damages is excluded to the extent permitted by law. Some states do not allow the exclusion or limitation so the above limitation or exclusion may not apply to you. This warranty gives you specific legal rights. In addition you may also have other rights, which vary from state to state.

GENERAL PROVISIONS

No warranty herein contained or set out shall apply when damage or repair is caused by any of the following:

1. Damage in transit.
2. Accident, alteration, abuse or misuse of product ie. exceeding weight capacities, applying inordinate pressure to footrest/leg rest, use in Mental Health facilities or like institutions.
3. Fire, water damage, theft, war, riot, hostility, acts of God.

Examples contained in this list are not to be construed as all-inclusive.



ISO 9001-2008 CERTIFIED



5516 Southwest 1st Lane
Ocala, Florida 34474

1-800-237-3377/ 352-854-2929/ Fax: 352-854-9544

e-mail: customerservice@wincomfg.com

www.wincomfg.com