

# Pacific Heights

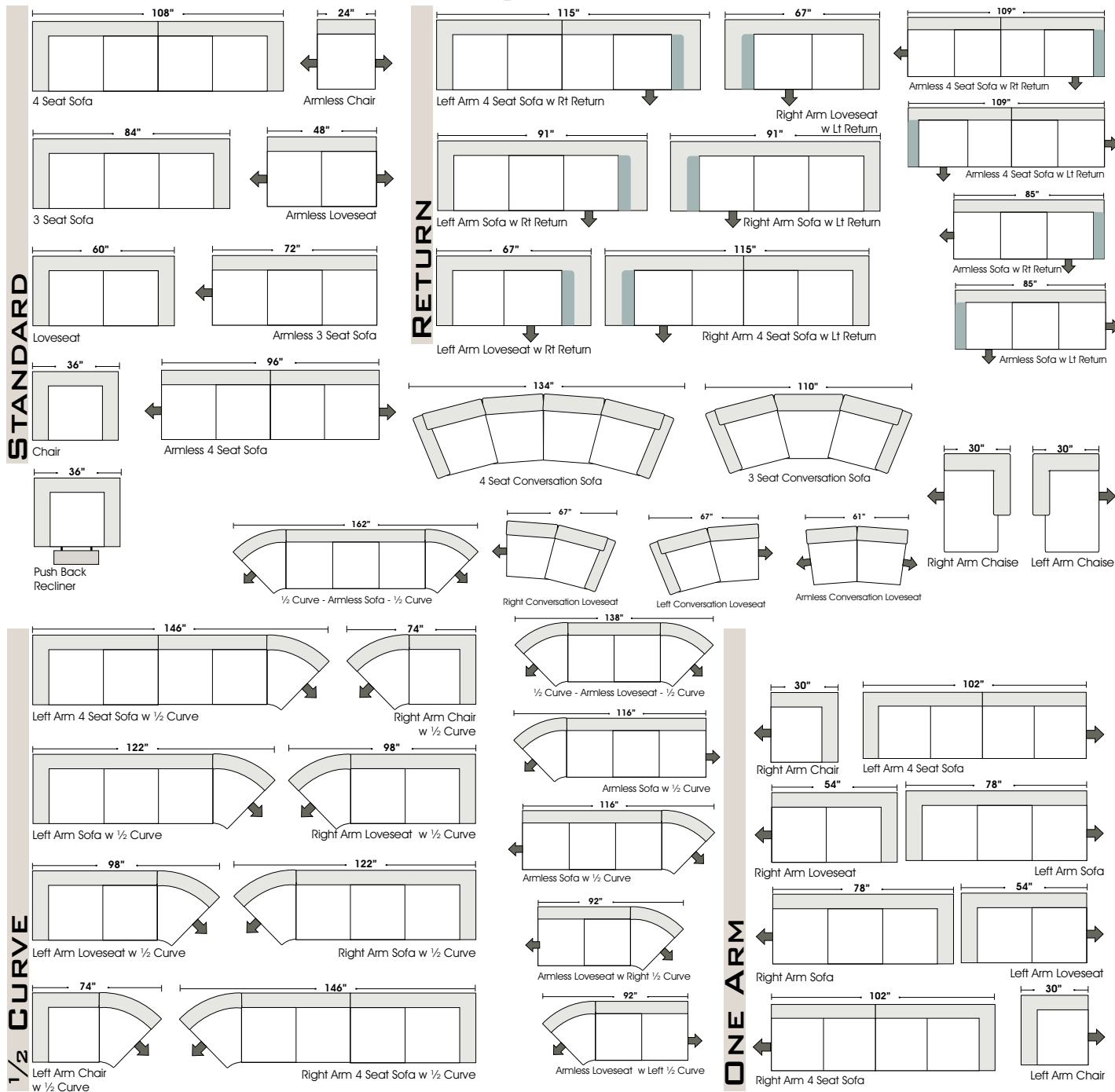

**Features** February 17, 2006

**Standard:**

- All Full or Top-Grain Leather
- All hardwood frames

**Options:**

- Down Seats (Additional Charges Apply)
- Down Backs (Additional Charges Apply)
- No. 33 Firm Seating

**Sleeper Options:**

- Deluxe Queen Mattress (Additional Charges Apply)
- Air Dream Queen Mattress (Additional Charges Apply)

**Special orders shipped within 4-6 weeks**

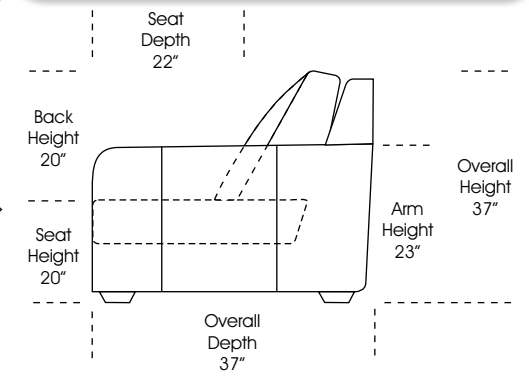

Note: All sizes are approximate.

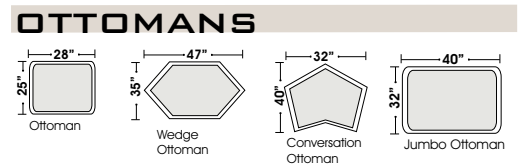

## Suggested Configurations

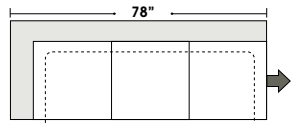

Left Arm Queen Sleeper

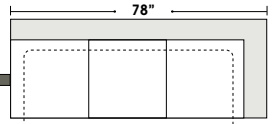

Right Arm Queen Sleeper

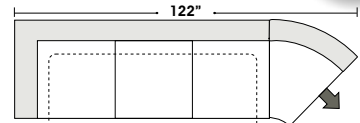

Left Arm Queen Sleeper  
w 1/2 Curve

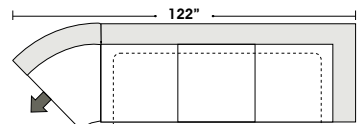

Right Arm Queen Sleeper  
w 1/2 Curve

